

L (mm)	Diffuser	Weight (kg)/ DI-IN	Dim. A
545	Opal/ MPRM	1.3/ n.a	-
1085	Opal/ MPRM	2.3/ 2.65	724
1380	Opal/ MPRM	2.9/ 3.31	1016
1625	Opal/ MPRM	3.2/ 3.7	1084
2170	Opal/ MPRM	4.5/ 5.35	1448

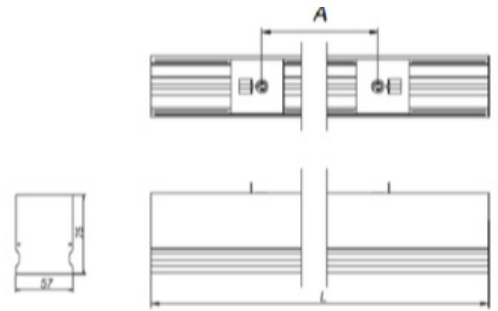

### INSTRUCTIONS

- a) Turn off power in electrical circuit.
- b) *Suspended mounting, DI version:*

Install regulator lines as in Fig.4., then insert cable through the regulator and connect the cable supply according to the markings as in Fig.2.

*Suspended mounting, DI-IN version:*

Remove the top opal cover of the luminaire. Install regulator lines as in Fig.4., Then pass cable and line through top cover. Slide the cover to the ceiling (temporarily at the time of installation luminaire). Then thread the lines through the regulators and connect the power cord under markings as in Fig.2, then turn down and click luminaire into the upper bowl. Note: Fixture 80 and 88W is made on two power circuits. It is possible for separate circuit switching of direct and indirect light. If you use one power circuit it must be connected to terminal No. 1 and 3.

- c) If the luminaire will be installed inline, before turning down the bowls assemble the fixtures according to the inline instructions below. For luminaires mounted autonomously cut lower bowl as in Fig.6. (OPAL version).

d) *Mounting inline:*

Installation of lighting inline follows by sliding in the first beam fasteners and tightening the screws as marked on Fig.5. Then slide second bar and tighten the screws. Connect plugs of through wiring and plug the power supply to one of the luminaires in the line according to the markings as in Fig.2.

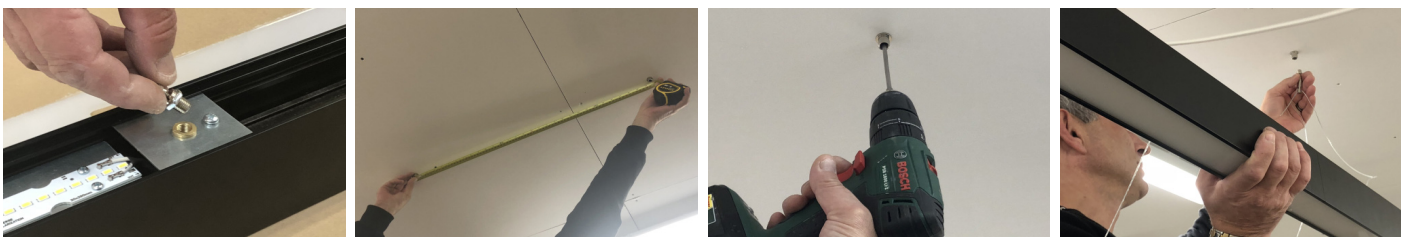

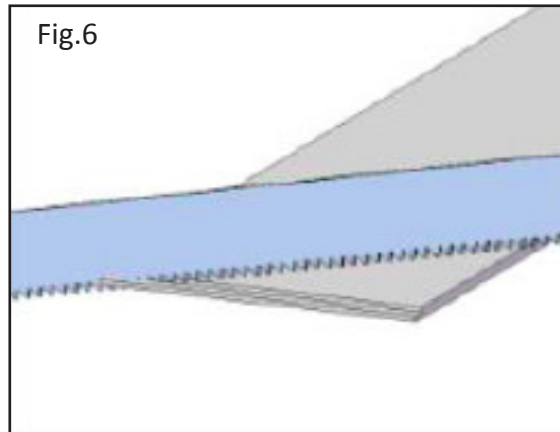
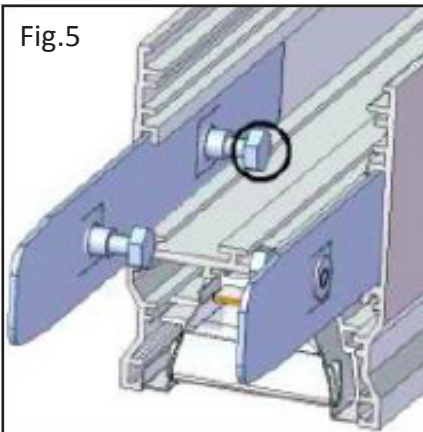
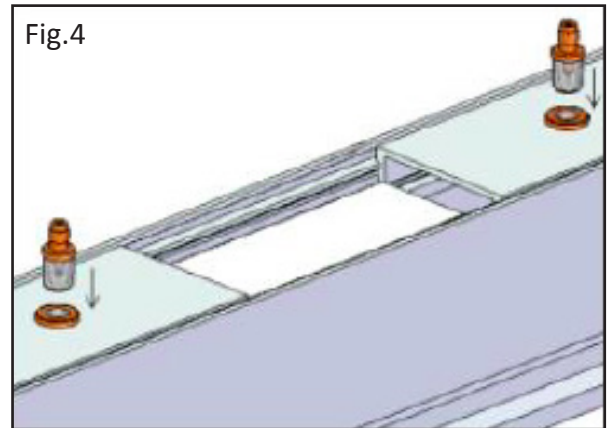
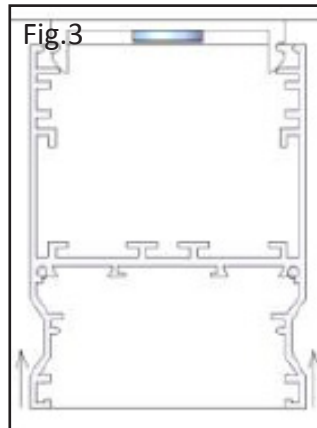
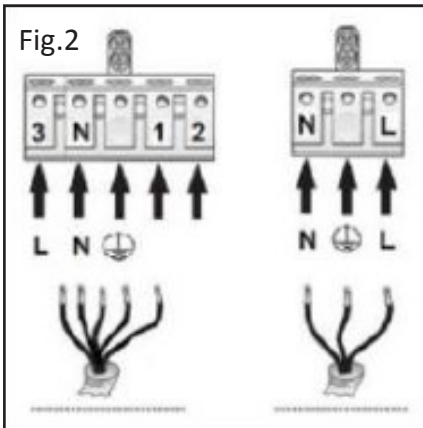

### IMPORTANT WARNINGS

Do not install the luminaire in areas without sufficient air circulation. The manufacturer cannot be considered liable for any damage caused by inappropriate use of the luminaire other than its manufactured purpose.

Luminaires must be installed by a qualified registered electrician only. Any misuse of the luminaire when power is activated may cause the risk of an electric shock.

The manufacturer does not accept any responsibility of any issues resulting from the non-compliance of the recommendations included in this instruction document. These instructions are issued as a guide to assist the installer to satisfactory conclusion.

The manufacturer reserves the right to change the design of this product without prior notice.

### WASTE DIRECTIVE

The European Directive 2002/96/EC on waste electrical and electronic equipment requires that electric and electronic devices must not be disposed of in the normal household waste. For correct disposal, please use authorized waste disposal facilities or return to the distributor at the date a new lighting fitting is purchased. Lamps, if disposed together with the lighting fitting, should not be broken up as they contain pollutants, which are harmful to the environment. Unauthorized disposal of the foregoing waste material is punishable by law.

